

STF-101-1010

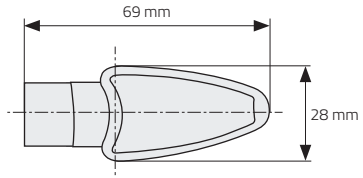

STF-101-1020

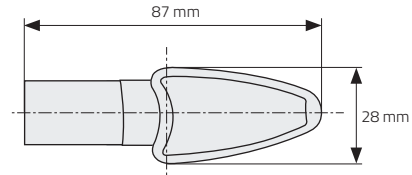

STF-101-1031

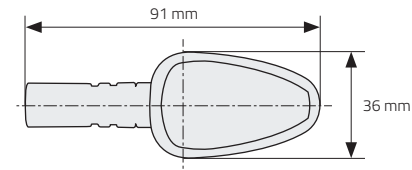

STF-101-1040

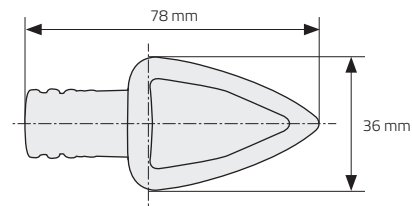

STF-101-1052

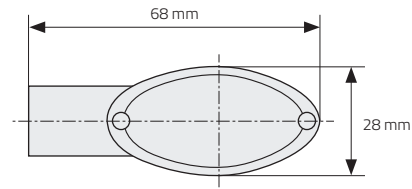

STF-101-3010

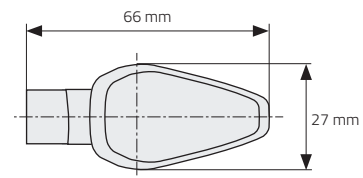

STF-101-3022

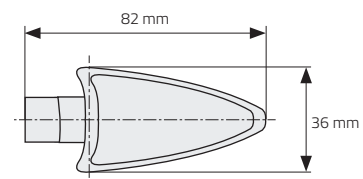

STF-101-3031

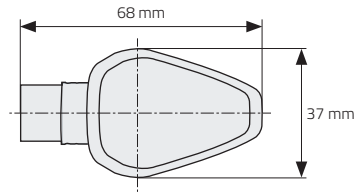

STF-101-3041

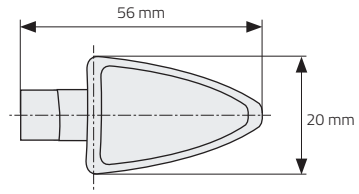

STF-101-5010

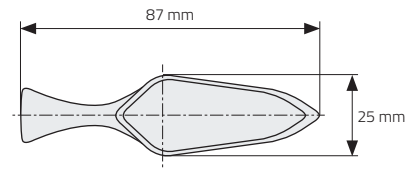

STF-101-5020

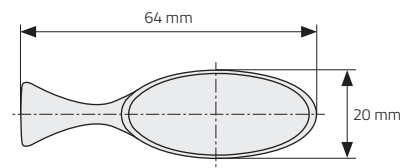

STF-101-9011

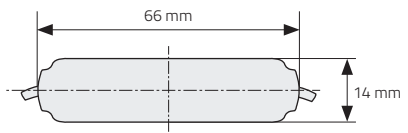

STF-101-9012

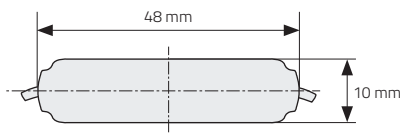

STF-201-1010

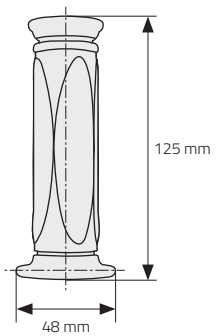

STF-201-1020

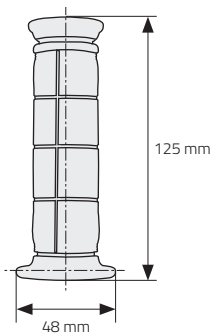

STF-201-1030

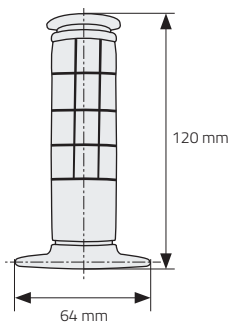

STF-201-1040

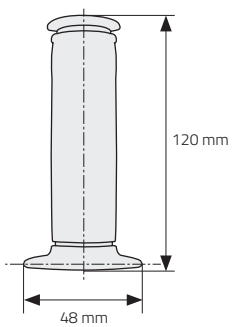

STF-201-1014

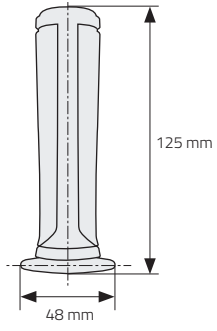

STF-201-1024

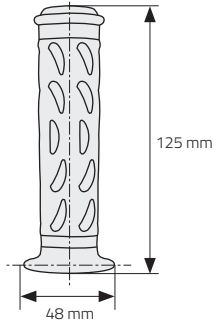

STF-201-2104

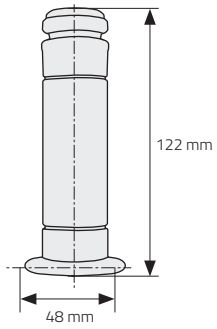

STF-201-2209

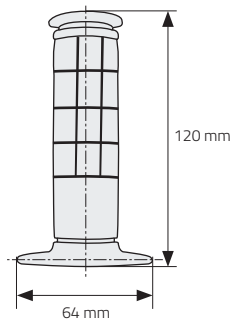

STF-201-3014

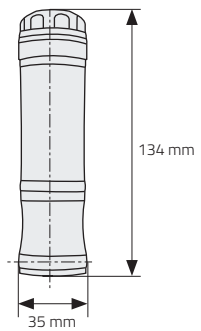

STF-201-3025

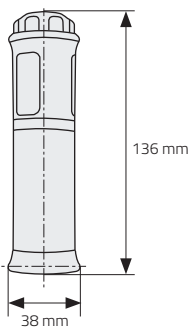

STF-202-1013

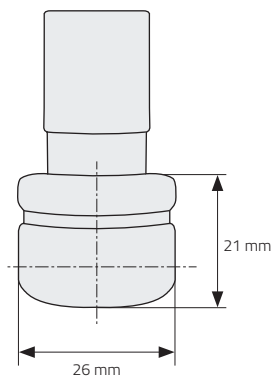

STF-202-1023

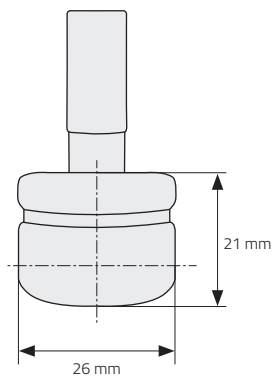

STF-202-1033

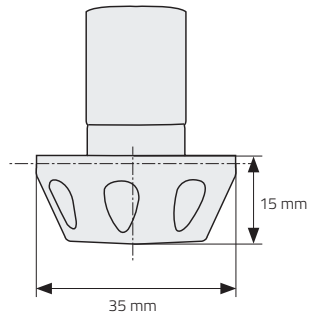

STF-650-1014

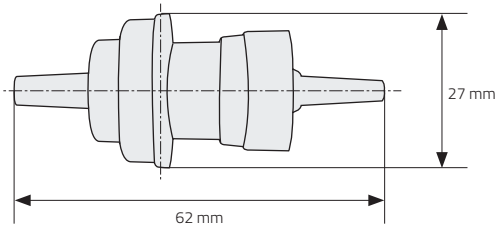

STF-650-1026

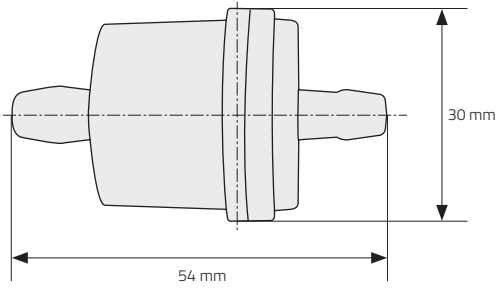

STF-650-2016

